

# New Warning Lights in 2019



New LED Warning Lightbar TBD9933 series

# Zhejiang Kindon Security Equipment Co., Ltd.

**KINDONSAFETY**®

Tel: +86 158 5851 5365

Email: sales@kindonsafety.com



Item No.: LTD641BR

Power: 12W, 4\*3W LEDs

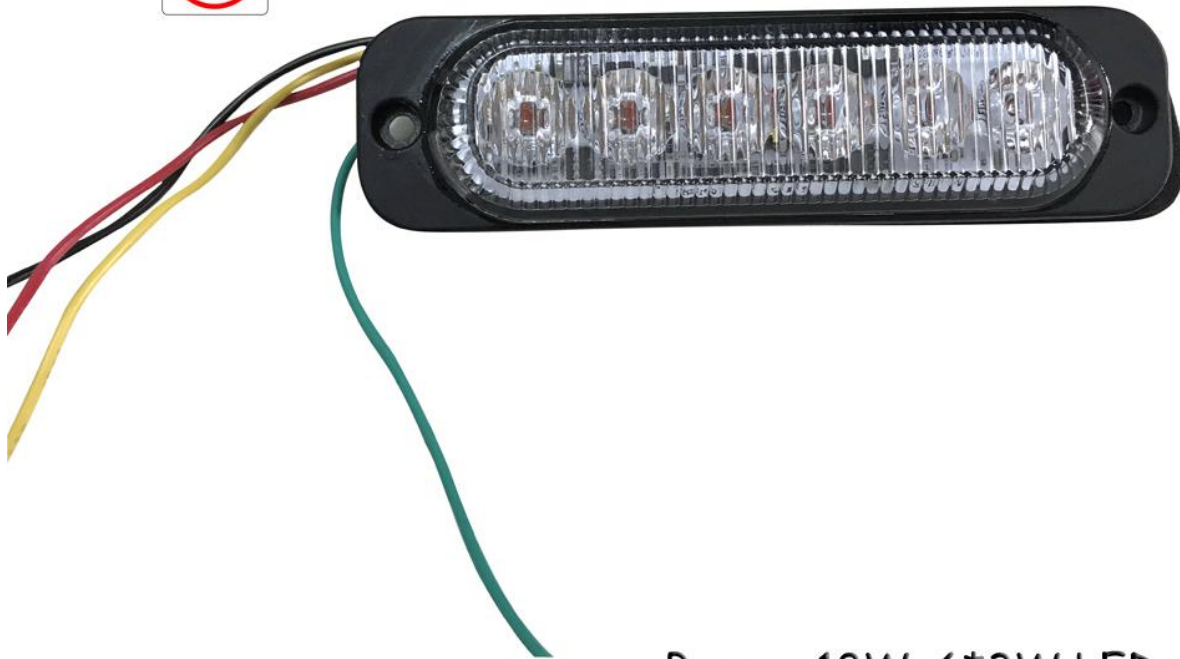

Item No.: LTD661BR

Power: 18W, 6\*3W LEDs

Size: 120\*32 mm

# Zhejiang Kindon Security Equipment Co., Ltd.

**KINDONSAFETY**®

Tel: +86 158 5851 5365

Email: sales@kindonsafety.com

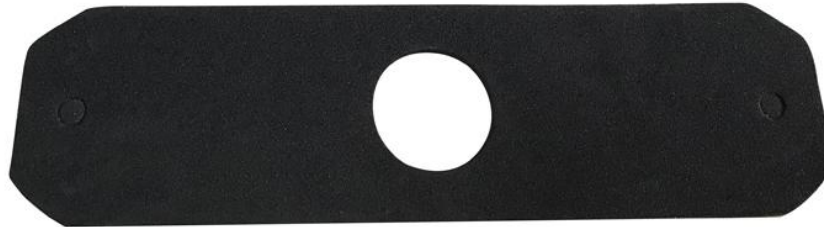
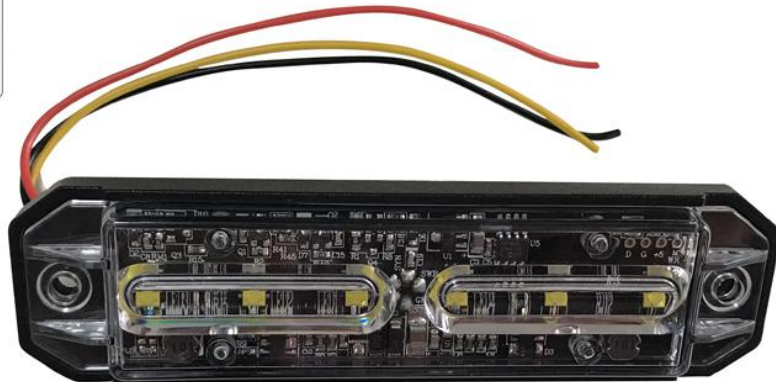

Item No.: LTD661DR

Power: 18W, 6\*3W Linear LEDs



Item No.: BL108 Power: 12\*3W LEDs

Size: 108\*55mm

# Zhejiang Kindon Security Equipment Co., Ltd.

**KINDONSAFETY**®

Tel: +86 158 5851 5365

Email: sales@kindonsafety.com



Item No.: BL91C Power: 8W Size: 91mm\*105mm



# Zhejiang Kindon Security Equipment Co., Ltd.

**KINDONSAFETY**<sup>®</sup>

Tel: +86 158 5851 5365

Email: sales@kindonsafety.com



Item No.: BL112C Power: 12W Size: 130mm\*112mm



Item No.: BL165C Power: 20W Size: 165mm\*103mm

# Zhejiang Kindon Security Equipment Co., Ltd.

**KINDONSAFETY**®

Tel: +86 158 5851 5365

Email: sales@kindonsafety.com

5W LEDs

9-30 V DC

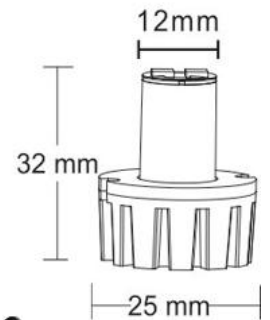

Part No.: LTD712-2

Part No.: LTD712

5W LEDs

9-30 V DC

Part No.: LTD712L-2

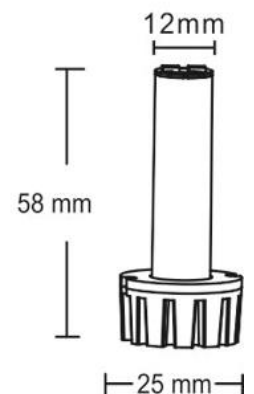

Part No.: LTD712L

# Zhejiang Kindon Security Equipment Co., Ltd.

**KINDONSAFETY**<sup>®</sup>

Tel: +86 158 5851 5365

Email: sales@kindonsafety.com

5W LEDs

9-30 V DC

Part No.: LTD725A-2

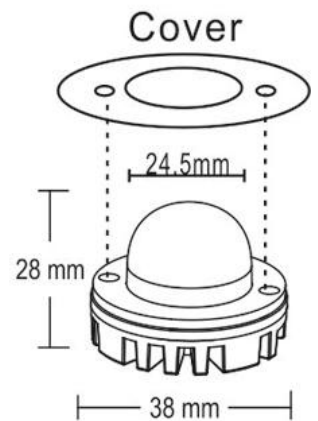

Part No.: LTD725A

5W LEDs

9-30 V DC

Part No.: LTD725C-2

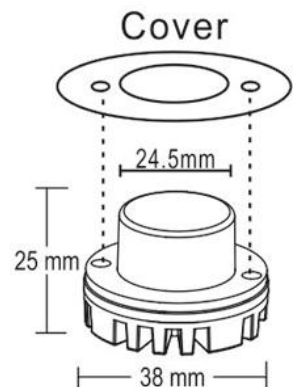

Part No.: LTD725C

# Zhejiang Kindon Security Equipment Co., Ltd.

**KINDONSAFETY**®

Tel: +86 158 5851 5365

Email: sales@kindonsafety.com

5W LEDs  
9-30 V DC

Part No.: LTD730-2

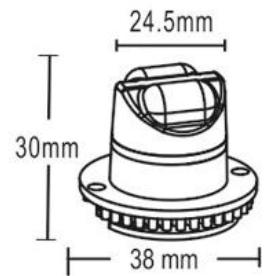

Part No.: LTD730

5W LEDs  
9-30 V DC



Part No.: LTD734-2

Part No.: LTD734